

**54W, 60cm, Angled Chimney Cooker Hood
Black**



IGCH06377B

Please read these instructions carefully before use and retain for future reference.

**Before switching on your appliance,
always check for any damage which may have been caused in transit.**

Issue | 271125

CONTENTS

Important Safety Instructions.....	3-4
Parts Included	5
Product Specification.....	6
Installation.....	7-10
Operating Instructions.....	11
Cleaning and Maintenance	12-14
Troubleshooting Guide	15
Fuse Replacement.....	16
Disposal Information.....	17
Igenix Warranty Terms & Conditions	18-19

IMPORTANT SAFETY INSTRUCTIONS

Please ensure you read all instructions and warnings in this user guide prior to first use. Keep this user guide for future reference.

- The installation and repair work must be undertaken by a qualified and competent person.
- The manufacturer disclaims all liability for any damage or injury caused as a result of not following the instructions of installation.
- The cooker hood supply should be 220V~240V/ 50Hz
- Children less than 8 years of age shall be kept away unless continuously supervised.
- This appliance is not intended for use by persons (including children) with reduced physical, sensory or mental capabilities, or lack of experience and knowledge, unless they have been given supervision or instruction concerning use of the appliance by a person responsible for their safety. Children should be supervised to ensure that they do not play with the appliance.
- Cleaning and user maintenance shall not be made by children without supervision.
- When the hood is in repair, maintenance, replacement of parts, please pull out the plug to ensure the safety of people.
- Plug the power cord into the power socket outlet with earthing continuity terminal.
- The cooker hood is for home use only, not suitable for commercial purposes.
- The cooker hood and its filter mesh should be cleaned regularly according to the instructions.
- Do not leave frying pans unattended during use as fats or oils may catch on fire.
- Do not try to use the cooker hoods without the grease filters or if the grease filters are excessively greasy.
- Do not use open flame or allow oil to go beneath the appliance.
- Do not check the status of the filters whilst the cooker hood is operating.
- Do not touch the light bulb within half an hour after appliance is used.
- Regulations concerning the discharge of air must be fulfilled.
- Extension sockets are forbidden.
- Please cut off the power before maintenance.









- This appliance has been designed for home use only and may cause danger if used in special occasions.
- If any fault occurs with the appliance, please call after-sale service department.
- Please keep the kitchen well-ventilated when in use.
- Prior to any maintenance or cleaning, ensure the power is off.
- Constantly check food frying to avoid the overheating of oil which may become a fire hazard.
- If the power cord is damaged, it must be replaced by the manufacturer, service agent or similarly qualified person in order to avoid a hazard.
- If the plug or cord is damaged, please call after-sale service centre.
- There is a fire risk if cleaning is not carried out in accordance with the instructions.
- In case of a damaged connecting wire, please refer to the manufacturer, after-sale service personnel or other qualified technicians.
- Use the unit according to the instructions to avoid fire hazard.
- There shall be adequate ventilation of the room when the range hood is used at the same time as appliances burning gas or other fuels.
- Do not flambé under the range hood.
- The air must not be discharged into a flue that is used for exhausting fumes from appliances burning gas or other fuels.
- To protect the main body from corrosion of the long-term accumulation of dirt, the cooker hood should be cleaned with hot water & non-corrosive detergent every 2 months.
- The minimum distance between the supporting surface for the cooking vessels on the hob and the lowest part of the range hood when the range hood is located above a gas appliance, shall be at least 65 cm. If the instructions for installation for the gas hob specify a greater distance, this must be taken into account. The distance of 65cm can be reduced for non-combustible parts of range hoods, and parts operating at safety extra low voltage, provided these parts do not give access to live parts if deformed.

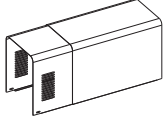

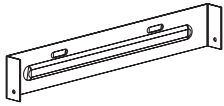
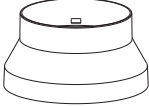
CAUTION: Accessible parts may become hot when used with cooking appliance.

PARTS INCLUDED

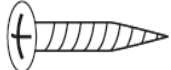
Important: The carbon filter is NOT included.

No.	Description	QTY	Images
1	Cooker Hood	1	
2	Inside & Outside Chimney	1	
3	Outside Chimney Bracket	1	
4	Inside Chimney Bracket	1	
5	Converter	1	
6	V-Flap	1 Pair	
7	Wall Plug	8	
8	ST4*40mm Screw	4	
9	ST4*30mm Screw	4	
10	ST4*8mm Screw	6	

PRODUCT SPECIFICATION

Model:	IGCH06377B
Power:	54W
Voltage/Frequency:	220V~240V/ 50Hz
Product Dimensions (mm):	H:343 x W:600 x D:312
Settings:	3 Settings (3-high, 2-medium, 1-low)
Net Weight:	10.7Kg
Energy Efficiency Rating:	A
Cable Length:	1.65m
Airflow at Maximum Speed in Normal Use:	355m ³ /h
Lamp Power:	2 x 2W
Electrical Class:	Class I

INSTALLATION (VENT)

MOUNTING OF V-FLAP

If the cooker hood does not have an assembled V-flap (1), you will need to mount the V-flap onto the main body of the vent.

Please use images bellow as a guide on how to do this.

- Mount the two half-parts (2) into the body (6)
- The pin (3) should be facing upwards
- The axis (4) should be inserted into the holes (5) on the main body
- Repeat all steps to for the second half-part.

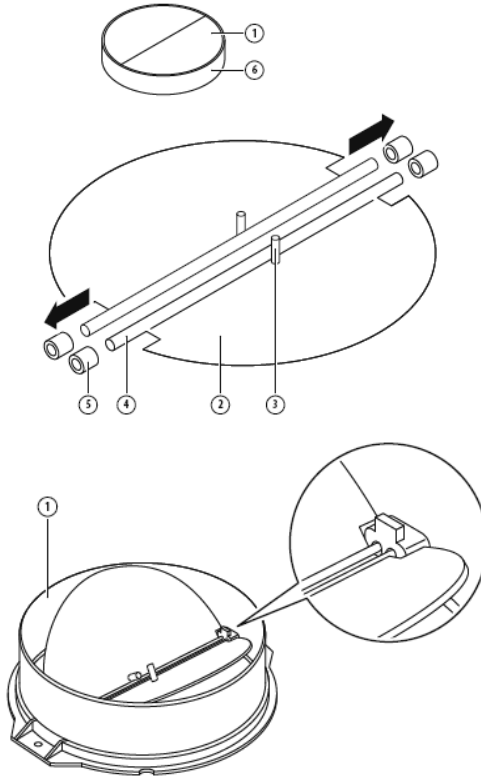

INSTALLATION

If you have an outlet on the outside, your cooker hood can be connected as below picture by means of an extraction duct (enamel, aluminium, flexible pipe or non-flammable material with an interior diameter of 120/150mm).

1. Before installation, turn the unit off and unplug it from the outlet.

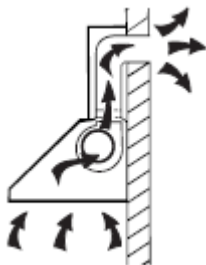

2. The cooker hood should be placed at a distance of 65~75cm above the cooking surface for best effect.

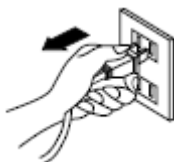

3. Measure the position of the holes for hanging the hood, inside chimney bracket, outside chimney bracket and safety holes. Drill 8 x 8mm holes and insert wall plugs into the holes. Fix the inside chimney bracket on the wall with 2 x ST4*40mm screws. Screw 2 x ST4*8mm screws in the hole for hanging the hood body. The screws installed should be 3-5mm out of the wall to hang the hood. The fixed position of the inside chimney bracket is the highest place of chimney. (Pic 2)

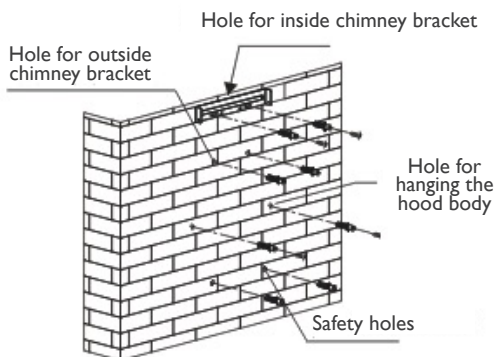

Pic 2

4. Install the converter, v-flap and expansion pipe onto the cooker hood. Fix the expansion pipe on the outlet with a cable tie. (Pic 3)

Please Note: The expansion pipe is not included in the product. Hang the cooker hood onto the hook. (Pic 4)

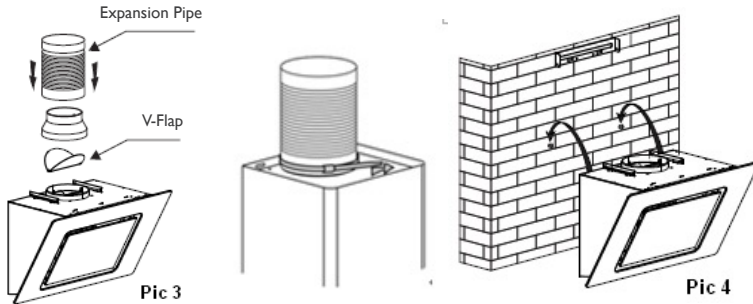

5. Install the outside chimney bracket onto the outside chimney with 2 x ST4*8mm screws. Ensure the inside chimney can be flexed freely. (Pic 5)
6. Fix the cooker hood with 2 x ST4*30mm safety screws. Note: The two safety vents are positioned on the back housing, with a diameter of 6mm. Put the two chimneys onto the cooker hood, fix the outside chimney on the wall with 2 x ST4*40mm screws and lead the expansion pipe to the outside. (Pic 6)

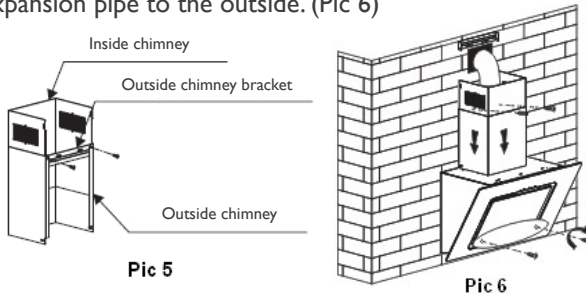

7. Adjust the height of the inside chimney to the position of the inside chimney bracket and fix it with 2 x ST4*8mm screws. Fix the outside chimney onto the hood body with 2 x ST4*8mm screws. (Pic 7)

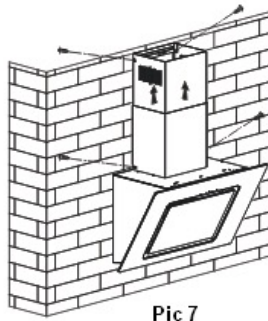

FOR EXHAUST DUCT INSTALLATION

Please ensure the following guide is followed in order to obtain optimal air extraction.

- Keep the expansion pipe short and straight.
- Do not reduce the size or restrict the expansion pipe.
- When using the expansion pipe, always install the pipe with minimal slack- This will minimise pressure loss.
- Any installation work must be carried out by a qualified electrician or competent person.
- Do not connect the ducting system of the hood to any existing ventilation system which is being used for any other appliance, e.g. warmer tube, gas tube, hot wind tube
- The angle of the bend of the expansion pipe should not fall below 120°, you must direct the pipe horizontally. Alternatively, the pipe should go up from the initial point and be led to an outer wall.
- After installation, ensure the range hood is level to avoid grease collection at one end.
- Ensure the expansion pipe selected for installation complies with relevant standards and is fire resistant.

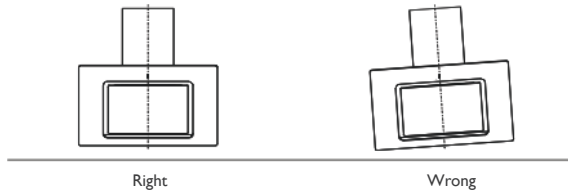

<p>WARNING:</p> 	<ul style="list-style-type: none">• For safety reason, please use only the same size of fixing or mounting screws which are recommended in this instruction manual.• Failure to install the screws or fixing device in accordance with these instructions may result in electrical hazards.
--	--

OPERATING INSTRUCTIONS

Push Button



Stop



Low



Mid



High



Lamp

- **Push the stop button:** The motor will stop.
- **Push the low button:** The motor will run at low speed.
- **Push the middle button:** The motor will run at mid speed.
- **Push the high button:** The motor will run at high speed.
- Push the light button and the two lights will illuminate. Push it again and the lights will turn off.

CLEANING AND MAINTENANCE



CAUTION: Before maintenance or cleaning is carried out, the cooker hood should be disconnected from the mains power supply. Ensure that the cooker hood is switched off at the wall and unplugged.

Please ensure the below cleaning instructions are followed as the external surfaces are susceptible to scratches and abrasions. Following this guide will ensure the best possible results are received without causing damage.

GENERAL

Cleaning and maintenance should be carried out when the appliance is cold. Avoid leaving alkaline or acid substances (lemon juice, vinegar etc.) on the surfaces for extended periods.

The stainless steel must be cleaned regularly (e.g. Weekly) to ensure a long-life expectancy. Dry with a clean, soft cloth. A specialized stainless steel cleaning fluid may be used.

Please Note: Ensure that wiping is done along with the grain of stainless steel to prevent any unsightly crisscross scratching patterns from appearing.

CONTROL PANEL SURFACE

The inlay control panel can be cleaned using warm soapy water. Ensure the cloth is clean and well wrung before cleaning. Use a dry soft cloth to remove any excess moisture left after cleaning.



Important: Using neutral detergents and avoid using harsh cleaning chemicals, strong household detergents or products containing abrasives, as this will affect the appearance of the appliance and potentially remove any printing of artwork on the control panel. This will also void the manufacturer's warranty.

GREASE MESH FILTERS

The mesh filters can be cleaned by hand. Soak them for approximately 3 minutes in water with a mild detergent and then brush it gently with a soft brush. Do not apply too much pressure to the filters whilst cleaning to avoid any damage. (Leave to dry naturally out of direct sun light.)

Filters should be washed separately to crockery and kitchen utensils. It is advisable not to use rinse aid.

To remove the grease filter, please see image to the right.

To install filters please follow these four steps:

- Angle the filter into the slots on the hood.
- Push the button on the handle of the filter.
- Release the handle once the filter fits into a resting position.
- Repeat to install all filters.

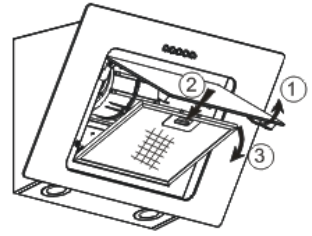

CARBON FILTER (Not included in the product)

Activated carbon filters can be used to trap odors. Normally the activated carbon filter should be changed every 3 to 6 months depending on the frequency of your usage. The installation procedure of activated carbon filter is as below:

- Match the hole of carbon filter to the installation buckle on both sides of blower.
- Turn the carbon filter until you feel it click into place.
- If you want to replace the filter, turn it anticlockwise until removed.

Please Note: Make sure the filter is securely locked. Otherwise, it will loosen and may cause danger.

Please Note: When activated carbon filter is attached, the suction power will be lowered.

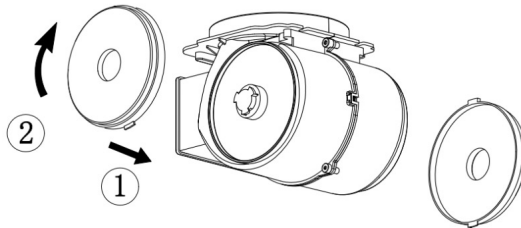

Replacement Bulb

IMPORTANT:



- The bulb must be replaced by the manufacturer, its service agent or similarly qualified persons.
- Always switch off the electricity supply before carrying out any operations on the appliance. When handling bulb, make sure it has completely cooled down before any direct contact with hands.
- When handling bulbs hold with a cloth or wear gloves to ensure perspiration does not come in contact with the bulb as this can reduce the life of the bulb.

- Remove the grease filter.
- Locate the junction box, unscrew the screws on the junction box cover, then take down the junction box cover (If there is wire pressing plate which retains the light wire, the wire pressing plate needs to be dismantled first) (Pic 1). Locate the terminal of the light connecting wire and pull it out. (Pic 2)
- Use a tool or the hand to press the spring splinter of both sides of LED light to the inside, until the light is pressed out, then slightly pull the light connecting wire out. (Pic 3)
- Apply the reverse procedure to install the light back.

Dimensions:

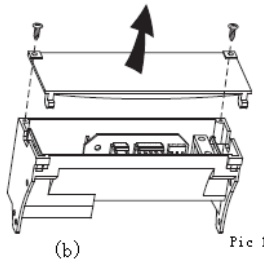
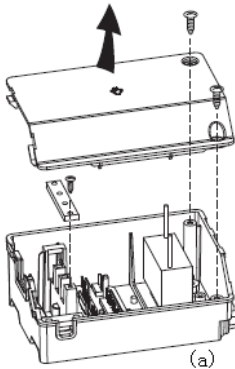
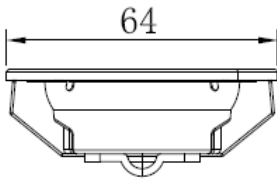

Pic 1

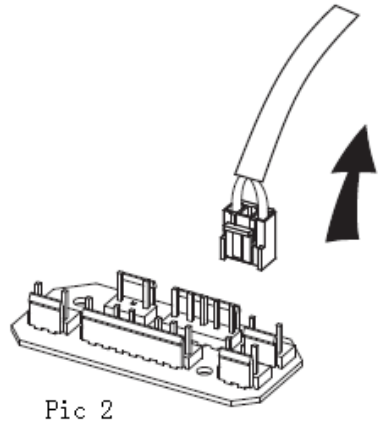

Pic 2

- ILCOS D code for this lamp is: DBR-2/65-H-64
- LED modules: round lamp
- Max wattage: 2×2W
- Voltage range: AC 110-240V

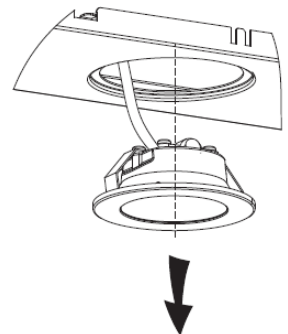
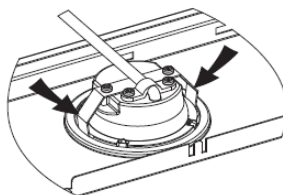

Pic 3

TROUBLESHOOTING GUIDE

If you experience difficulties with the appliance, please check the suggestions below before contacting customer services on 01473 271272:

Fault	Possible Cause	Solution
Light on but motor does not work	Fan switch turned off	Select a fan switch position
	Fan switch failed	Contact service center
	Motor failed	Contact service center
Light and motor does not work	House fuses blown	Reset/Replace fuses
	Mains power cable is loose or disconnected	Refit mains power cable to power outlet Switch power outlet on
Oil leakage	One way valve and the outlet are not tightly sealed	Take down the one-way valve and seal with sealant
	Leakage from the connection of chimney and cover	Take chimney down and seal
Lights not working	Broken or faulty bulbs	Replace bulbs as per the instructions further along in this manual
Insufficient suction	The distance between the cooker hood and the gas top is too far	Refit the cooker hood to the correct distance
The cooker hood inclines	The fixing screw is not tight enough	Tighten the hanging screw and make it horizontal



Please Note:

Any electrical repairs to this appliance must conform to your local, city and federal laws. Please contact the service center if in any doubt before undertaking any of the above. Always disconnect the unit from the power source when opening the unit.

MAINS PLUG FUSE REPLACEMENT



Fuse Cover

Fuse Replacement (Class I)

This appliance must be earthed. Remove the fuse cover with a small flat head screw driver. Take out the fuse and replace with a new fuse of the same Amp. Replace the fuse cover and push back into place.

DISPOSAL INFORMATION

The European Directive 2012/19/EU on Waste Electrical and Electronic Equipment (WEEE), requires that old household electrical appliances must not be disposed of in normal unsorted municipal waste.



Old appliances must be collected separately in order to optimise the recovery and recycling of the materials they contain and reduce the impact on human health and the environment.

The crossed out “wheeled bin” symbol on the product reminds you of your obligation, that when you dispose of the appliance it must be separately collected. Consumers should contact their local authority or retailer for information concerning the correct disposal of their old appliance.

Igenix Warranty Terms & Conditions

This product is guaranteed for a period of 12 months as standard from the date of purchase against mechanical and electrical defects. You can extend your warranty for a further 12 months by registering your product.

Upon registration we will cover your product for a period of 24 months from the original purchase date against any mechanical or electrical defects.

To qualify for the warranty, the product must be used for domestic household use only and in accordance with the instructions in the user manual. Any misuse of the product will result in the warranty being void.

The warranty does not cover accidental damage, misuse, neglect, tampering or incorrect adjustment or installation.

The warranty will be rendered invalid if the product is resold, has had its serial number removed (or has an invalid serial number), or if an unauthorised person has carried out any repairs or alterations.

The warranty does not cover accessories or consumable parts that require replacement under normal use. This includes shelving, dials, filters, belts and trays etc.

In the unlikely event of a breakdown please refer to the Troubleshooting guide in your user manual and check all plugs, fuses and the electricity supply.

If you still require assistance please contact our Customer Service department on **01473 271 272** or write to us at the following address:

**Customer Service Department
38 Bluestem Road, Ransomes Europark
Ipswich, IP3 9RR**

Please quote the Product Code which begins 'IG' or 'DF' and the PO Number on the rating label, and give details of the exact fault. We will then decide whether to repair or replace the item.

Before we arrange the repair or replacement you will be required to return a copy of your proof of purchase. Please retain your original.

If an item is replaced within the agreed warranty period, the warranty for the replacement item will be calculated from the purchase date of the original.

In the event that the product is inspected and no fault is found or the product is not within the warranty period you will be charged for the repair and any carriage costs.



Thank you for choosing Igenix

As a valued customer we would like to offer you a FREE 2 year warranty to cover your product against any electrical or mechanical defects.

This means that in the unlikely event you develop a fault or problem with your product we will happily repair or replace the item free of charge.

To qualify for the 2 year warranty you must register your product within 30 days of purchase. The full Terms & Conditions of our warranty policy are shown on the opposite page. They are also available on our website. **www.igenix.co.uk**

igenix

UK: 38 Bluestem Road, Ransomes Europark, Ipswich, IP3 9RR

EU: Castle Electrical Factors Ltd., Dundalk, A91 KA9R, IR

Tel. 01473 271 272

Disclaimer: Igenix operate a policy of continual improvement and development.
We therefore reserve the right to change/alter the specification and appearance of our appliances without prior notice.
All diagrams and images shown in this manual are for illustration purposes only.