

## 800W 20L Digital Microwave



## IG2096/IG2097

PO Number:

**Please read these instructions carefully before use and retain for future reference**

**Before switching on your appliance,  
always check for any damage which may have been caused in transit**

## **CONTENTS**

Important Safety Instructions.....	3-5
Suitable Cookware .....	6
Technical Specification .....	7
Appliance Overview .....	7
Installation.....	8
Operating Instructions.....	9-12
Cleaning & Maintenance.....	13
Trouble Shooting Guide.....	14
Fuse Replacement.....	15
Disposal Information.....	15
Terms and Conditions and Warranty Information.....	16-17

## IMPORTANT SAFETY INSTRUCTIONS

Read and follow all of the instructions even if you feel you are familiar with the product, and find a place to keep this manual handy for future reference.

**Important:** This appliance is intended for use in a domestic environment only. Any other use is not recommended by the manufacturer and may cause fire, electrical shocks or other injury to user or property.

When using electrical appliances, basic safety precautions should always be followed:

- Carefully read all instructions before operating and save for future reference.
- This appliance is for normal domestic use only.
- This appliance can be used by children aged from 8 years and above if they have been given supervision or instruction concerning the use of the appliance in a safe way and understand the hazards involved.
- Cleaning and user maintenance shall not be made by children unless they are older than 8 years and supervised.
- Keep the appliance and its cord out of reach of children aged less than 8 years.
- Children shall not play with the appliance.
- Appliances can be used by persons with reduced physical, sensory or mental capabilities or lack of experience and knowledge if they have been given supervision or instruction concerning use of the appliance in a safe way and understand the hazards involved.
- If the supply cord is damaged, it must be replaced before further use by the manufacturer, a service agent or similarly qualified persons in order to avoid a hazard.
- Before using the appliance, ensure that the voltage of your electricity supply is the same as that indicated on the rating plate of the appliance. In the UK this is 220-240 Volts AC.
- It is hazardous for anyone other than a qualified service technician to carry out any service or repair operation that involves the removal of a cover which gives protection against exposure to microwave energy.

- Do not store or use this appliance outdoors.
- Do not use this microwave oven near water, in a wet basement or near a swimming pool.
- Read and follow the specific section named “Precautions to Avoid Possible Exposure to Excessive Microwave Energy”.
- When heating food in a plastic or a paper container, keep an eye on the microwave oven due to the possibility of ignition.
- If smoke is emitted, switch off or unplug the appliance and keep the door closed in order to stifle any flames.
- Locate this oven only in accordance with the installation instructions provided.
- Liquids and other foods must not be heated in sealed containers since they are liable to explode.
- Only use containers suitable for use in microwave ovens.
- Do not overcook food.
- Remove wire twist-ties and metal handles from paper or plastic containers/bags before placing them in microwave oven.
- Eggs in the shell and whole hard-boiled eggs should not be heated in microwave oven since they may explode, even after microwave heating has ended.
- The oven should be cleaned regularly and any food deposits should be removed.
- Failure to maintain the microwave oven in a clean condition could lead to deterioration of the surface that could adversely affect the life of the appliance and possibly result in a hazardous situation.
- Do not use the microwave oven cavity for storage purposes.
- The appliance is not intended to be operated by means of an external timer or separate remote-control system.
- Steam cleaners should not be used to clean the microwave oven.
- The contents of feeding bottles and baby food jars should be stirred or shaken and the temperature checked before consumption, in order to avoid burns.
- Microwave heating of beverages can result in delayed eruptive boiling. Care must be taken when handling the container.

- During use the appliance becomes hot. Care should be taken to avoid touching hot surfaces and heating elements inside the microwave oven and vents should not be covered.
- The microwave oven should not be placed in any cabinets or units unless cabinet or unit has been approved to house a microwave.
- Touching some of the internal components can cause serious injury. Do not disassemble this appliance.

## **Precautions to Avoid Possible Exposure to Excessive Microwave Energy**

1. Do not attempt to operate this microwave oven with the door open since this can result in harmful exposure to microwave energy. It is important not to break or tamper with the safety interlocks.
2. Do not place any object between the microwave oven front face and the door or allow debris or cleaner residue to accumulate on sealing surfaces.



**WARNING:** If the door or door seals are damaged, the microwave oven must not be operated until it has been repaired by a qualified technician.

### **Suitable Cookware to use in Microwaves**

1. The ideal material for a microwave utensil is a microwave safe transparent plastic dish.
2. Microwaves cannot pass through metal. Metallic utensils, dishes with metallic trim and aluminium foil should not be used.
3. Do not use recycled paper products when microwave cooking as they may contain small metal fragments which can cause sparks and/or fires.
4. Round/oval dishes rather than square dishes are recommended, as food in the corners tends to overcook.

Cookware	Microwave Cooking
Heat Resistant Glass	YES
Non Heat Resistant Glass	NO
Heat Resistant Ceramics	YES
Microwave Safe Plastics	YES
Metal Tray	NO
Aluminium Foil	NO
Metal Rack	NO
Foil Containers	NO
Kitchen Paper	YES

# SPECIFICATION

Model:	IG2096 / IG2097
Voltage/Frequency:	230-240V ~ 50Hz
Rated Input Power(Microwave):	1250W
Rated Output Power(Microwave):	800W
Oven Capacity:	20L
Turntable Diameter:	255mm
External Dimensions (H x W x D):	258 x 440 x 357mm
Cavity Dimensions (H x W x D):	205 x 306 x 304mm
Net Weight:	10.53kg

# APPLIANCE OVERVIEW

## Names of Microwave Parts and Accessories

Remove the microwave and all materials from the carton and microwave cavity. Your microwave comes with the following accessories:

Glass tray x1

Turntable ring assembly x1

Instruction Manual x1

- A) Control panel
- B) Turntable shaft
- C) Turntable ring assembly
- D) Glass tray
- E) Observation window
- F) Door assembly
- G) Safety interlock system

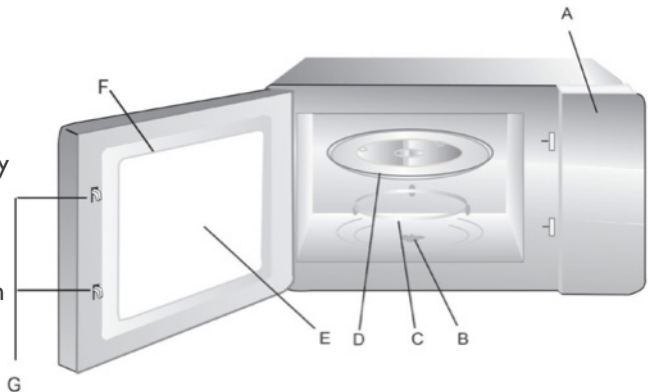

1. Never place the glass tray upside down. The glass tray should never be restricted.
2. Both glass tray and turntable ring assembly must always be used during cooking.
3. All food and containers of food are always placed on the glass tray for cooking.
4. If glass tray or turntable ring assembly cracks or breaks, contact our Igenix customer service team

## COUNTERTOP INSTALLATION

Remove all packing material and accessories. Examine the microwave for any damage such as dents or a broken door. Do not install if microwave is damaged.

**Cabinet:** Remove any protective film found on the microwave cabinet surface. Do not remove the light brown Mica cover that is attached to the microwave cavity to protect the magnetron.

## INSTALLATION

1. Select a level surface that provides enough open space for the intake and/or outlet vents.

(1) The minimum installation height is 85cm.

(2) The rear surface of the appliance should be placed against a wall. Leave a minimum clearance of 30cm above the microwave, a minimum clearance of 20cm is required between the microwave and any adjacent walls.

(3) Do not remove the legs from the bottom of the microwave.

(4) Blocking the intake and/or outlet openings can damage the microwave.

(5) Place the microwave as far away from radios and TV as possible. Operation of the microwave may cause interference to your radio or TV reception.

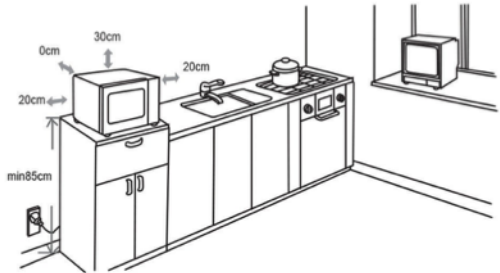

2. Plug your microwave into a standard household outlet. Be sure the voltage and the frequency is the same as the voltage and the frequency on the rating label.



**WARNING:** Do not install microwave over a range cooktop or other heat-producing appliances. If installed near or over a heat source, the microwave could be damaged and the warranty would be void.





The accessible surface may be hot during operation.



# OPERATING INSTRUCTIONS

## I. Clock Setting

When the microwave oven is turned on, the oven will display “0:00”, and the buzzer will sound once.

1. Press **“Clock/Pre-set”** once. “00:00” displays.
2. Turn “” to adjust the hour figures, the input time should be within 0--23(24-hour).
3. Press **“Clock/Pre-set”** and the minute figures will flash.
4. Turn “” to adjust the minute figures, the input time should be within 0--59.
5. Press **“Clock/Pre-set”** to finish clock setting. “:” will flash.

**Note:** If the clock is not set, it will not function when powered.

During the process of clock setting, if no operation occurs within 1 minute the oven will go back to the previous status automatically.

## 2. Microwave Cooking

1. Press **“Microwave”** and the LED will display “P100”.
2. Press **“Microwave”** to choose the power you want, and “P100”, “P 80”, “P 50”, “P 30” or “P 10” will display in order.
3. Then press **“Start/+30SEC./Confirm”** to confirm.
4. Turn “” to adjust the cooking time.. (The maximum cooking time is 95 minutes.)
5. Press **“Start/+30SEC./Confirm”** again to start cooking.

**Example:** If you want to use 80% microwave power to cook for 20 minutes, you can operate the oven with the following steps:

1. Press **“Microwave”** once, the screen displays “P100”.
2. Press **“Microwave”** once again to choose 80% microwave power.
3. Press **“Start/+30SEC./Confirm”** to confirm, and the screen displays “P 80”.
4. Turn “” to adjust the cooking time until the oven displays “20:00”.
5. Press **“Start/+30SEC./Confirm”** to start cooking.

**Note:** The step quantities for the adjustment time of the coding switch are as follow:

0---1 min: 5 seconds

1---5 min: 10 seconds

5---10 min: 30 seconds

10---30 min: 1 minute

30---95 min: 5 minutes

Press	Once	Twice	3 times	4 times	5 times
Microwave Power	100%	80%	50%	30%	10%

### 3. Speedy Cooking

1. In stand by press **“Start/+30SEC./Confirm”** to cook with 100% power level for 30 seconds. Each time you press on the same key it will increase by 30 seconds. The maximum cooking time is 95 minutes.
2. During the microwave and time defrost process, press **“Start/+30SEC./Confirm”** to increase the cooking time.
3. In stand by turn  left to choose the cooking time directly. After choosing the time, press **“Start/+30SEC./Confirm”** to start cooking. The microwave power is 100%.

**Note:** Under the states of auto menu and weight defrost the cooking time cannot be increased by pressing **“Start/+30SEC./Confirm”**

### 4. Defrost By Weight

1. Press **“W.T./Time Defrost”** once, the screen will display “dEF1”.
2. Turn  to select the food weight. The range of weight is 100-2000g.
3. Press **“Start/+30SEC./Confirm”** to start defrosting.



### 5. Defrost By Time

1. Press **“W.T./Time Defrost”** twice, the screen will display “dEF2”.
2. Turn  to select the cooking time.
3. Press **“Start/+30SEC./Confirm”** to start defrosting.

## 6. Multi-Stage Cooking

A maximum of two stages can be set. If one stage is defrosting, it will be put in the first stage automatically. The buzzer will sound once after each stage and the next stage will begin.



**Example:** If you want to defrost the food for 5 minutes, then to cook with 80% microwave power for 7 minutes. The steps are as follows:

1. Press **“W.T./Time Defrost”** twice, the screen will display “dEF2”;
2. Turn “” to adjust the defrost time to 5 minutes;
3. Press **“Microwave”** once;
4. Turn “” to choose 80% microwave power till “P80” displays;
5. Press **“Start/+30SEC./Confirm”** to confirm;
6. Turn “” to adjust the cooking time of 7 minutes;
7. Press **“Start/+30SEC./Confirm”** to start cooking.



## 7. Pre-set Function

1. Set the clock first. (Consult the instruction of Clock Setting.)
2. Input the cooking program. Two stages can be set at most. Defrosting should not be set in preset function.

**Example:** if you want to cook with 80% microwave power for 7 minutes.



1. Press **“Microwave”** once;
2. Turn “” to choose 80% microwave power until “P80” displays;
3. Press **“Start/+30SEC./Confirm”** to confirm;
4. Turn “” to adjust the cooking time of 7 minutes;

After the above steps, please **do not** press **“Start/+30SEC./Confirm”**, instead do as follows:

5. Press **“Clock/Pre-set”** until the hour time displays;
6. Turn “” to adjust the hour time which should be within 0--23.
7. Press **“Clock/Pre-set”** and the minute time will display.
8. Turn “” to adjust the minute time which should be within 0--59.
9. Press **“Start/+30SEC./Confirm”** to finish setting. “:” will display, the buzzer will sound twice when the correct time arrives, then cooking will start automatically.

**Note:** the clock must be set first. Otherwise the pre-set function will not work.

## 8. Auto Menu

1. In waiting states, turn “” right to choose the menu from “A-1” to “A-8”;
2. Press “**START/+30SEC./CONFIRM**” to confirm the menu you choose;
3. Turn “” to choose the food weight;
4. Press “**START/+30SEC./CONFIRM**” to start cooking.
5. After cooking finish, the buzzer sounds five times.

Menu	Weight	Display	Power
A-1 AUTO REHEAT	200g	200	100%
	400g	400	
	600g	600	
A-2 VEGETABLE	200g	200	100%
	300g	300	
	400g	400	
A-3 FISH	250g	250	80%
	350g	350	
	450g	450	
A-4 MEAT	250g	250	100%
	350g	350	
	450g	450	
A-5 PASTA	50g(with water 450 g)	50	80%
	100g(with water 800 g)	100	
A-6 POTATO	200g	200	100%
	400g	400	
	600g	600	
A-7 PIZZA	200g	200	100%
	400g	400	
A-8 SOUP	200ml	200	80%
	400ml	400	

## CLEANING & MAINTENANCE

Be sure to unplug the appliance from the power supply.

1. Clean the cavity of the microwave after use with a slightly damp cloth.
2. Clean the accessories in the usual way in soapy water.
3. The door frame and seal and neighbouring parts must be cleaned carefully with a damp cloth when they are dirty.
4. Do not use harsh abrasive cleaners or sharp metal scrapers to clean the microwave door glass since they can scratch the surface, which may result in shattering of the glass.

**Cleaning Tip---**For easier cleaning of the cavity walls that the cooked food can touch: Place half a lemon in a bowl, add 300ml (1/2 pint) water and heat on 100% microwave power for 10 minutes. Wipe the microwave clean using a soft, dry cloth.

## UTENSILS CAUTION

**Personal Injury Hazard:** It is hazardous for anyone other than a qualified engineer to carry out any service or repair operation that involves the removal of a cover which gives protection against exposure to microwave energy.

See the instructions on “Suitable Cookware to use in Microwaves.” There may be certain non-metallic utensils that are not safe to use for microwaving. If in doubt, you can test the utensil in question following the procedure below:

### Utensil Test:

1. Fill a microwave-safe container with 1 cup of cold water (250ml) along with the utensil in question.
2. Cook on maximum power for 1 minute.
3. Carefully feel the utensil. If the utensil is warm, do not use it for microwave cooking.
4. Do not exceed 1 minute cooking time.

## TROUBLE SHOOTING GUIDE

If you experience difficulties with the appliance, please check the suggestions below before contacting customer services on 01473 271272:

To test microwave is working before cooking food – DO NOT operate empty, instead place one cup of water (approx. 150ml) in a glass in the microwave and close the door securely. Microwave lamp should go off if the door is closed properly. Let the microwave work on full power for 1 min.

Normal	
Microwave oven interfering TV reception	Radio and TV reception may be interfered when microwave oven operating. It is similar to the interference of small electrical appliances like mixer, vacuum cleaner, and electric fan. It is normal
Dim oven light	In low power microwave cooking, oven light may become dim. It is normal
Steam accumulating on door, hot air out of vents	In cooking, steam may come out of food. Most will get out from vents. But some may accumulate on cool place like oven door. It is normal
Oven started accidentally with no food in	It is forbidden to run the unit without any food inside. It is very dangerous

Problem	Possible Cause	Possible Solution
Microwave cannot be started	Power cord is not plugged in tightly.	Unplug. Then plug in again after 10 seconds
	Fuse blowing	Replace fuse
	Trouble with outlet	Test outlet with other electrical appliances
Microwave does not heat	Door not closed properly	Close door fully
Glass turntable makes noise when microwave oven operates	Debris stuck between turntable ring and bottom of microwave	Refer to “Cleaning and Maintenance” section to clean dirty parts

## MAINS PLUG FUSE REPLACEMENT

### Fuse Replacement (Class I)

This appliance must be earthed. Remove the fuse cover with a small flat head screw driver. Take out the fuse and replace with a new fuse of the same Amp. Replace the fuse cover and push back into place.

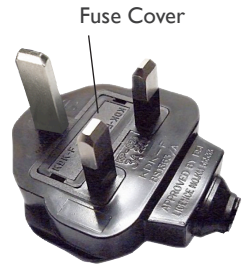

## DISPOSAL INFORMATION

The European Directive 2012/19/EU on Waste Electrical and Electronic Equipment (WEEE), requires that old household electrical appliances must not be disposed of in normal unsorted municipal waste.

Old appliances must be collected separately in order to optimise the recovery and recycling of the materials they contain and reduce the impact on human health and the environment.

The crossed out “wheeled bin” symbol on the product reminds you of your obligation, that when you dispose of the appliance it must be separately collected. Consumers should contact their local authority or retailer for information concerning the correct disposal of their old appliance.





## Igenix Warranty Terms & Conditions

This product is guaranteed for a period of 12 months as standard from the date of purchase against mechanical and electrical defects. You can extend your warranty for a further 12 months by registering your product.

Upon registration we will cover your product for a period of 24 months from the original purchase date against any mechanical or electrical defects.

To qualify for the warranty, the product must be used for domestic household use only and in accordance with the instructions in the user manual. Any misuse of the product will result in the warranty being void.

The warranty does not cover accidental damage, misuse, neglect, tampering or incorrect adjustment or installation.

The warranty will be rendered invalid if the product is resold, has had its serial number removed (or has an invalid serial number), or if an unauthorised person has carried out any repairs or alterations.

The warranty does not cover accessories or consumable parts that require replacement under normal use. This includes shelving, dials, filters, belts and trays etc.

In the unlikely event of a breakdown please refer to the Troubleshooting guide in your user manual and check all plugs, fuses and the electricity supply.

If you still require assistance please contact our Customer Service department on **01473 271 272** or write to us at the following address:

**Customer Service Department  
38 Bluestem Road, Ransomes Europark  
Ipswich, IP3 9RR**

Please quote the Product Code which begins 'IG' or 'DF' and the PO Number on the front of the manual, and give details of the exact fault. We will then decide whether to repair or replace the item.

Before we arrange the repair or replacement you will be required to return a copy of your proof of purchase. Please retain your original.

If an item is replaced within the agreed warranty period, the warranty for the replacement item will be calculated from the purchase date of the original.

In the event that the product is inspected and no fault is found or the product is not within the warranty period you will be charged for the repair and any carriage costs.





## **Thank you for choosing Igenix**

As a valued customer we would like to offer you a FREE 2 year warranty to cover your product against any electrical or mechanical defects.

This means that in the unlikely event you develop a fault or problem with your product we will happily repair or replace the item free of charge.

To qualify for the 2 year warranty you must register your product within 30 days of purchase. The full Terms & Conditions of our warranty policy are shown on the opposite page. They are also available on our website. **[www.igenix.co.uk](http://www.igenix.co.uk)**





# **igenix**

**38 Bluestem Road, Ransomes Europark, Ipswich, IP3 9RR**

**Tel. 01473 271 272**

Disclaimer: Igenix operate a policy of continual improvement and development.  
We therefore reserve the right to change/alter the specification and appearance of our appliances without prior notice.  
All diagrams and images shown in this manual are for illustration purposes only.