

20 Litre Manual Microwave White



For models:

IG2071 – 700W

IG2083 – 800W

PO Number:

Please read these instructions carefully before use and retain for future reference

**Before switching on your appliance,
always check for any damage which may have been caused in transit**



CONTENTS

Important Safety Instructions.....	3-5
Appliance Overview	6-7
Installation.....	7-8
Operating Instructions.....	8
Container Guidelines	9
Cooking Tips	10
Cleaning & Maintenance	11
Trouble Shooting Guide.....	12
Fuse Replacement.....	13
Disposal Information.....	13
Terms and Conditions and Warranty Information.....	14-15

IMPORTANT SAFETY INSTRUCTIONS

The following basic precautions should always be followed when using this electrical appliance:

- Carefully read all instructions before operating and save for future reference.
- This appliance is for normal domestic use only.
- Make sure the voltage in the intended location corresponds to the one shown on the rating label of the appliance.
- To reduce the risk of fire in the microwave cavity ensure the following:
 - Do not cook the food for longer than recommended.
 - Remove wire twist-ties before placing bags in the microwave.
 - Do not heat oil or fat for deep frying as the temperature of the oil cannot be controlled.
 - After use wipe the waveguide cover with a damp cloth, followed by a dry cloth to remove any food splashes and grease. Built-up grease may overheat and begin to cause smoke or catch fire.
 - If materials inside the microwave should smoke or ignite, keep the microwave door closed, turn the microwave off at the wall socket and disconnect the plug from the wall socket.
 - When heating food in plastic containers, do not leave unattended due to the possibility of ignition.
- To reduce the risk of explosion and sudden boiling:
 -  Liquids and other foods must not be heated in sealed containers since they are liable to explode; baby bottles fitted with a screw cap or teat are considered to be sealed containers.
 - Use a wide-mouthed container to cook liquids and ensure the cooked liquid is allowed to stand and is not removed immediately- This is to avoid possible hazards such as explosion caused by delayed boiling of liquids.
 - Potatoes, sausages and chestnuts should be peeled or pierced before cooking. Eggs in their shell should not be heated in microwaves since they may explode, even after microwave heating has ended.

- The contents of feeding bottles and baby food jars should be stirred or shaken and the temperature should be checked before consumption, in order to avoid burns from uneven heating.
- If the supply cord is damaged, it must be replaced before further use by the manufacturer, a service agent or a qualified electrician in order to avoid a hazard.
- After cooking, the container will be very hot. Use sufficient protection such as gloves to remove the food and avoid steam burns by directing steam away from the face and hands.
- Slowly lift the furthest edge of dish covers and microwave plastic wrap and carefully open popcorn and microwave cooking bags away from the face to avoid risk of burns from escaping steam.
- To prevent the turntable from breaking:
 - Let the turntable cool down before cleaning.
 - Do not place hot foods or containers on the cold turntable.
 - Do not place frozen foods or containers on the hot turntable.
- Make sure the containers do not touch the interior walls during cooking.
- Only use containers that are marked as “microwave safe”.
- Do not store food or any other object inside the microwave.
- Do not operate the microwave without any liquid or food inside the microwave. This could damage the microwave.
- Any accessories not recommended by the manufacturer may cause injuries.
- Do not use outdoors.
- Retain these instructions for future reference.
-  If the door or door seals are damaged or the microwave has malfunctioned, the microwave must not be operated until it has been repaired by a qualified electrician.
-  **WARNING:** It is hazardous for anyone other than a qualified electrician to carry out any service or repair operation that involves the removal of a cover which gives protection against exposure to microwave energy.
- If smoke is emitted, switch off and then unplug the appliance and keep the door closed in order to contain any flames.

- Microwave heating of beverages can result in delayed boiling and the possibility of overflowing; therefore care must be taken when handling the container.
- Do not use harsh abrasive cleaners or sharp metal scrapers to clean the microwave door glass since they can scratch the surface, which may result in shattering of the glass.
- The lamp of the microwave oven is not intended for other purposes.
- The appliances are not intended to be operated by means of an external timer or separate remote -control system.
- This microwave oven is intended for heating food and beverages.

Drying of food or clothing and heating of warming pads, slippers, sponges, damp cloth and similar may lead to risk of injury, ignition or fire.

- This appliance should only be used by adults.
- Children shall not play with the appliance.
- Cleaning and user maintenance shall not be made by children.
- Keep the appliance and its cord out of reach of children.
- This appliance is not intended for use by persons (including children) with reduced physical, sensory or mental capabilities, or lack of experience and knowledge.
- A steam cleaner is not to be used on any part of this product.
- The door or the outer surface may get hot when the appliance is operating.



WARNING: Accessible parts may become hot during use. Young children should be kept away.

During use the appliance becomes hot. Care should be taken to avoid touching heating elements inside the microwave.



CAUTION: Hot surface

APPLIANCE OVERVIEW

1. Door lock - Microwave door must be properly closed in order for it to operate.
2. Viewing window - Allows user to see the cooking status.
3. Rotating axis - The glass turntable sits on the axis; the motor underneath it drives the turntable to rotate.
4. Rotating ring - The glass turntable sits on its wheels; it supports the turntable and helps it to balance when rotating.
5. Turntable - The food sits on the turntable, its rotation during operation helps to cook food evenly.

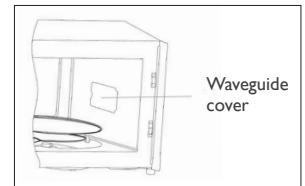
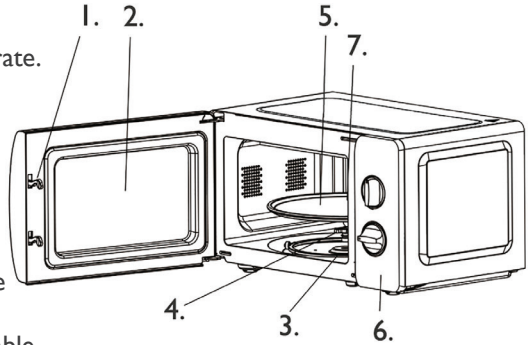

CAUTION:

- Place the rotating ring in the microwave first.
- Fit the turntable onto the rotating axis and make sure that it is located over the gear mechanism.

6. Control panel - See control panel section for full details*.
7. Waveguide cover - It is inside the microwave, next to the wall of control panel.



WARNING: Never remove the waveguide cover

CONTROL PANEL

*(the control panel is subject to change without prior notice).

1. Timer
 - The max cooking time length that can be set is 30 minutes.
 - Each setting increment is 1 minute.
 - A bell ring will be heard when the timer times out and returns to Zero position.
2. Function/Power knob

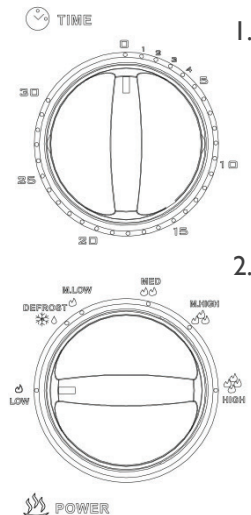

There are 5 power levels and a defrost setting:

HIGH (H)	100% power output	(Quick cooking)
M.HIGH (M.H)	85% power output	(Normal cooking)
MED (M)	66% power output	(Slow cooking)
M.LOW (M.L)	40% power output	(Drinks or soup)
DEFROST (D)	37% power output	(Defrost)
LOW (L)	17% power output	(Keep warm)

The following table provides a reference defrost time length for various foods:

	WEIGHT RANGE	DEFROST TIME (Minutes)
Meat	0.1~1.0kg	1:30~26:00
Poultry	0.2~1.0kg	2:30~22:00
Seafood	0.1~0.9kg	1:30~14:00

INSTALLATION

1. Take out all the packing. If there is a safety film over the microwave, tear it off before use. Check carefully for damage. If any damage is evident, immediately notify dealer or send to the manufacturer's service center.
2. Microwave ovens must be placed in dry and non-corrosive environments and kept away from heat and humidity, such as gas burners or water tanks.
3. To ensure sufficient ventilation, the distance from the back of the microwave to the wall should be at least 10cm, the side to the wall should be at least 5cm, the free distance above the top surface at least 20cm and the distance from the microwave to the ground should be at least 85cm.
4. The position of the microwave should be such that it is located at least 5m from any TVs, Radios or antenna as this can cause picture disturbance.
5. The appliance must be positioned so that the plug is accessible and must ensure a good grounding in case of leakage.
6. The microwave must be operated with the door closed.
7. The microwave must not be placed in a cabinet. The microwave is intended to be freestanding.

8. As there could be manufacturing residue or oil remaining in the microwave cavity or on the heating element, it is normal for there to be an odor or slight smoke upon initial use. This should not occur after the microwave has been used several times. Keep the door and windows open to ensure good ventilation. It is strongly recommended to place a cup of water on the turntable, set the microwave to high power and operate for 2-3 minutes to reduce the risk of residual odor before cooking food and beverages for the first time, repeating several times if necessary.

OPERATING INSTRUCTIONS

Plug the plug into the wall socket- Before connecting the cord, make sure the timer is set to “0” position. Do not block the ventilation outlets.

- Place the food in a container and onto the glass turntable and close the door.
- Select the desired power level.
- Set the timer:
If desired time is less than 10 minutes then turn the timer knob to the over 10 minutes position and then turn back to the desired time setting.
- Once the desired time is set cooking will begin. If pausing is required whilst cooking then the door can be opened at any time by pressing the door release button, this will pause the cooking- Closing the door again will resume cooking.
- When the timer ends and cooking is finished, the microwave produces a bell ring and the inside lamp will be automatically turned off.
If desired cooking level is reached and food is therefore removed before the timer finishes then ensure the timer is reset to the “0” position to avoid the microwave operating whilst empty when the door is closed again.

CONTAINER GUIDELINES

It is strongly recommended to use containers which are marked as microwave safe. Generally speaking containers which are made of heat-resistant ceramic, glass or plastic are suitable for microwave cooking. Never use metal containers for microwave cooking as sparking is likely to occur. Use the below table for reference:

Container Material	Microwave	Notes
Heat-resistant ceramic	Yes	Never use ceramics which are decorated with metal or glazed.
Heat-resistant plastic	Yes	Do not leave unattended due to the possibility of ignition.
Heat-resistant glass	Yes	Never use glass with metal parts.
Plastic film	Yes	Should not be used when cooking meat as the over-temperature may do damage to the film.
Grill rack	No	Should not be used in microwave. Microwave cannot penetrate through metal.
Metal container	No	Should not be used in microwave. Microwave cannot penetrate through metal.
Lacquer	No	Poor heat-resistance. Cannot be used for High-temperature cooking.
Bamboo wood and paper	No	Poor heat-resistance. Cannot be used for High-temperature cooking.

COOKING TIPS

The following factors may affect the cooking result:

Food arrangement

Place thicker areas towards the outside of the dish and the thinner part towards the centre and spread evenly. Do not overlap if possible.

Cooking time

Start cooking with a short time setting, evaluate it after it times out and extend it according to the actual need. Over cooking may result in smoke and burns.

Cooking food evenly

Food such as chicken, hamburgers or steak should be turned at least once during cooking.

Depending on the type of food, if applicable remove it and stir it from outside to centre of dish once or twice during cooking.

Allow standing time

After timer is finished, leave the food in the microwave for an adequate length of time, this allows it to complete its cooking cycle and begin cooling down in a gradual manner.

Whether the food is cooked

Color and hardness of food help to determine if it is done, these include:

- Steam coming out from all parts of food, not just the edge
- Joints of poultry can be moved easily
- Pork or poultry shows no signs of blood
- Fish is opaque and can be sliced easily with a fork

Microwave safe plastic wrap

When cooking food with high fat content, do not allow the plastic wrap to come into contact with food as it may melt.

Microwave safe plastic cookware

Some microwave safe plastic cookware might not be suitable for cooking foods with high fat and sugar content. The preheating time specified in the cooking instructions of each food/beverage must not be exceeded.

CLEANING & MAINTENANCE

Microwave Oven Care



CAUTION: The microwave should be cleaned regularly and any food deposits removed.



WARNING: Turn off the power at the wall socket and remove the power cord from the wall socket before cleaning. Do not immerse any part of the appliance in water or other fluids when cleaning- except the removable glass turntable and rotating ring.

- Failure to maintain the microwave in a clean condition could lead to deterioration of the surfaces which could adversely affect the life of the appliance and possibly result in a hazardous situation.
- Never use strong detergent, gasoline, abrasive powder or a metal brush to clean any part of the appliance.
- Do not remove the waveguide cover (located on the inner walls as per the diagram contained within the product instructions section of this manual).

Tips for Cleaning

Details for cleaning door seals, cavity and adjacent parts:

Exterior:

- Wipe the enclosure with a dampened soft cloth.

Door:

- Using a dampened soft cloth, wipe clean the door and window.
- Wipe the door seals and adjacent parts to remove any spill or spatter.
- Wipe the control panel with a slightly dampened soft cloth.

Interior walls:

- Wipe clean the cavity with a dampened soft cloth.
- Wipe clean the waveguide cover to remove any food splashed.

Turntable/ Rotation ring/ Rotation axis:

- Remove and wash with mild soapy water.
- Rinse with clean water and allow to dry thoroughly before replacing.

TROUBLE SHOOTING GUIDE

If you experience difficulties with the appliance, please check the suggestions below before contacting customer services on 01473 271272:

To test microwave is working before cooking food – DO NOT operate empty, instead place one cup of water (approx. 150ml) in a glass in the microwave and close the door securely. Microwave lamp should go off if the door is closed properly. Let the microwave work on full power for 1 min.

Fault	Possible Cause	Solution
The microwave does not work.	Not properly plugged into the mains wall socket.	Plug in firmly.
	Not switched on.	Make sure appliance is switched on.
	No electricity in the mains wall socket.	Check fuse.
	Door not shut properly.	Ensure nothing is blocking the door (if food container is too large, use smaller container).
Food is not cooked	Time or power setting is not correct for required food/ beverage.	Ensure cooking instructions from packaging are followed and appropriate setting and time is selected.
	Door is not closed.	Ensure door is fully closed.
	No electricity in the mains wall socket.	Check fuse.
Food is over or undercooked	Time or power setting is not correct for required food/beverage.	Ensure cooking instructions from packaging are followed and appropriate setting and time is selected.
Sparkling or noises inside the microwave	Container used is made of metal components or unsuitable material for microwaving.	Ensure any container used adheres to guidelines in manual.
	Metal utensil has been left in container.	Ensure no metal utensils are left in containers.
Cooling fan is not working	Air flow to vents is blocked.	Ensure nothing is blocking the air vents and that the microwave is situated as per the installation instructions.
Turntable is not rotating	Door is not properly closed.	Ensure door is properly closed.
	Container is touching the walls and preventing turntable from rotating.	Ensure container is not touching the walls (if food container is too large, use smaller container).

CAUTION- HIGH VOLTAGE WARNING



This appliance is equipped with an earthed plug for your protection against possible shock hazards and should be connected to a properly earthed power socket.

Do not operate this oven if the door is bent, warped or otherwise damaged and does not close firmly.

Do not tamper with the door safety interlocks.

This device is to be serviced only by a qualified electrician.

Disconnect power plug from the mains before servicing.

MAINS PLUG FUSE REPLACEMENT

Fuse Replacement (Class I)

This appliance must be earthed. Remove the fuse cover with a small flat head screw driver. Take out the fuse and replace with a new fuse of the same Amp. Replace the fuse cover and push back into place.

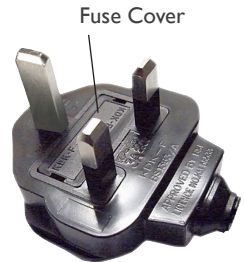

DISPOSAL INFORMATION

The European Directive 2012/19/EU on Waste Electrical and Electronic Equipment (WEEE), requires that old household electrical appliances must not be disposed of in normal unsorted municipal waste.

Old appliances must be collected separately in order to optimise the recovery and recycling of the materials they contain and reduce the impact on human health and the environment.

The crossed out “wheeled bin” symbol on the product reminds you of your obligation, that when you dispose of the appliance it must be separately collected. Consumers should contact their local authority or retailer for information concerning the correct disposal of their old appliance.





Igenix Warranty Terms & Conditions

This product is guaranteed for a period of 12 months as standard from the date of purchase against mechanical and electrical defects. You can extend your warranty for a further 12 months by registering your product.

Upon registration we will cover your product for a period of 24 months from the original purchase date against any mechanical or electrical defects.

To qualify for the warranty, the product must be used for domestic household use only and in accordance with the instructions in the user manual. Any misuse of the product will result in the warranty being void.

The warranty does not cover accidental damage, misuse, neglect, tampering or incorrect adjustment or installation.

The guarantee will be rendered invalid if the product is resold, has had its serial number removed (or has an invalid serial number), or if an unauthorised person has carried out any repairs or alterations.

The warranty does not cover accessories or consumable parts that require replacement under normal use. This includes shelving, dials, filters, belts and trays etc.

In the unlikely event of a breakdown please refer to the Troubleshooting guide in your user manual and check all plugs, fuses and the electricity supply.

If you still require assistance please contact our Customer Service department on **01473 271 272** or write to us at the following address:

**Customer Service Department
38 Bluestem Road, Ransomes Europark
Ipswich, IP3 9RR**

Please quote the Product Code which begins 'IG' or 'DF' and the "PO Number" on the front of the instruction manual and give details of the exact fault. We will then decide whether to repair or replace the item.

Before we arrange the repair or replacement you will be required to return a copy of your proof of purchase. Please retain your original.

If an item is replaced within the agreed guarantee period, the guarantee for the replacement item will be calculated from the purchase date of the original.

In the event that the product is inspected and no fault is found or the product is not within the guarantee period you will be charged for the repair and any carriage costs.



Thank you for choosing Igenix

As a valued customer we would like to offer you a FREE 2 year warranty to cover your product against any electrical or mechanical defects.

This means that in the unlikely event you develop a fault or problem with your product we will happily repair or replace the item free of charge.

To qualify for the 2 year warranty you must register your product within 30 days of purchase. The full Terms & Conditions of our warranty policy are shown on the opposite page. They are also available on our website. **www.igenix.co.uk**

To register your product, visit the Igenix website and complete the online form.

igenix

38 Bluestem Road, Ransomes Europark, Ipswich, IP3 9RR

Tel. 01473 271 272

Disclaimer: Igenix operate a policy of continual improvement and development.
We therefore reserve the right to change/alter the specification and appearance of our appliances without prior notice.
All diagrams and images shown in this manual are for illustration purposes only.